



## Two-Channel Wireless Edge System

**FC** MODEL: MWR22B, MWT12B, MWTA12B

### WARNING

Read and understand all instructions before beginning installation. Disconnect power to motor and test upon completion. Wireless sensing edge systems should be installed by qualified personnel to ensure the requirements herein have been met. Keep these instructions with the installation. Always abide by local and national electrical code specifications when wiring accessories to motor controls.

Avoid visible cords and reels with the **Two-Channel Wireless Edge Receiver (MWR22B) and Transmitter (MWT12B and/or MWTA12B) System**. This system is designed to provide a wireless signal transmission from a non-monitored sensing edge to motor controls with on-board diagnostics for easy setup and troubleshooting. The transmitter is available with an optional audible alarm that activates when the battery has 25% of power remaining. Consult your manual for detailed instructions about connecting to the motor.

### CONTENTS

One of the following:

- **MWR22B Two-Channel Wireless Edge Receiver**
- **MWT12B Wireless Edge Transmitter**
  - (4) #6 x 3/4" self-drilling transmitter mounting screws
  - (2) AA 1.5V alkaline batteries
- **MWTA12B Wireless Edge Transmitter with Low Battery Alarm**
  - (4) #6 x 3/4" self-drilling transmitter mounting screws
  - (2) AA 1.5V lithium batteries

**Note:** To pair a Wireless Edge Transmitter (**MWT12B** or **MWTA12B**) with a Single-Channel Wireless Edge Receiver (**MWR12B**), please refer to the installation instructions at [www.milleredge.com](http://www.milleredge.com).

### REQUIRED (not included)

- Miller Edge sensing edge:
  - 2-Wire non-monitored
- 1/8" flat blade screwdriver
- 1/4" flat blade screwdriver
- #2 Phillips screwdriver
- 18-26 AWG wire to connect receiver to operator

### RECOMMENDED

- Coaxial cable for exterior mounted antenna
- Coaxial bulkhead adapter, female/female
- Multimeter capable of reading measuring continuity
- MET-101 Edge Tester by Miller Edge
- Receiver mounting hardware
- Operator manufacture's manual

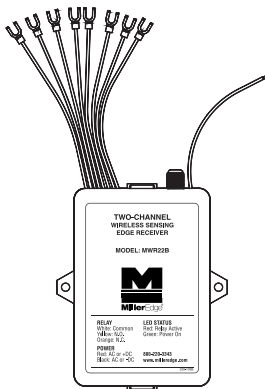

IMAGE 1: MWR22B  
Two-Channel Wireless Edge System



IMAGE 3: MWT12B  
Wireless Edge Transmitter



IMAGE 3: MWTA12B Wireless Edge  
Transmitter with Low Battery Alarm

MWR22B-MWT12B-MWTA12B\_Inst\_20240412

### I. RECEIVER INSTALLATION

1. Remove the operator cover and turn **off** the power to the operator.
2. Determine where to place the antenna (outside of any metal enclosures) so it is in the line of sight with the transmitter(s) during the entire range of travel.

IMAGE 3

3. Remove the receiver lid and mount receiver base inside the operator (hardware not provided), positioning it for optimum ease of wiring.
4. Depending on which interface the operator uses, wire the receiver as follows: TABLE 1

TABLE 1: RECEIVER WIRING INDICATORS	
<b>Red</b>	(+) Power: 12-24 V AC/DC
<b>Black</b>	(-) Power: 12-24 V AC/DC
<b>White</b>	Connect to low voltage common terminal on operator.
<b>Yellow</b>	If the operator requires a <b>normally open</b> contact, connect yellow to the operator's sensing edge input.
<b>Orange</b>	If the operator requires a <b>normally closed</b> contact, connect orange to the operator's sensing edge input.
<b>Green</b>	Antenna: Place outside of any metal enclosure to provide for optimal signal.
<b>F Connector</b>	F connector antenna fitting included for an external antenna if needed.

5. Turn **on** power to the operator and confirm the receiver is powered by observing that the green receiver LED turns on. IMAGE 3

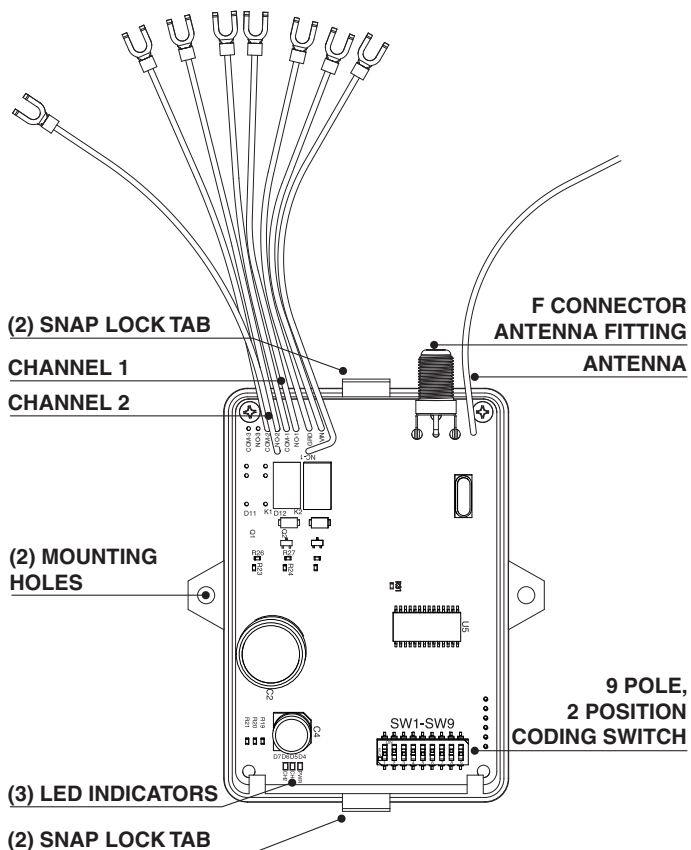

IMAGE 3: RECEIVER BASE DETAIL

TABLE 2: LED INDICATORS			
RECEIVER	Green	On	Power is on
		Off	No power
	CH1: Red	On	Active edge
		Off	Inactive edge
CH2: Red	On	Active edge	
	Off	Inactive edge	
TRANSMITTER	Green	On: 3 secs	Test or active edge
		Off	Inactive edge

### II. TRANSMITTER SETUP & PAIRING

1. Remove the lid of the transmitter and insert the two AA batteries onto the removable circuit board, paying attention to their polarity. **IMAGE 4**
2. Set the 9 pole, 2 position coding switch on both the receiver and the transmitter to match. **IMAGE 5**
  - Any switch position will work as long as the transmitter and receiver are exactly matched and different from other nearby MW wireless systems.
  - Switch #9 (SW9) determines programming to channel 1 or channel 2: **IMAGE 5**
    - **Channel 1:** Position SW9 to on.
    - **Channel 2:** Position SW9 to off.
  - **To pair a receiver or transmitter manufactured prior to April 2024 (models MWR12, MWR13, MWT12, MWTA12), proceed to the coding switch addendum on page 6.**
3. Test the system by momentarily pressing the transmitter test button and observe: **IMAGE 6, TABLE 2**
  - a. The green transmitter LED turns on for 3 seconds.
  - b. The red receiver corresponding channel LED turns on.

**Tech Tip:** To save time in the field, pair the receiver and transmitter(s) in advance of installation with a 12-24 V power supply.

### III. TRANSMITTER INSTALLATION

**Note:** Modifying the NEMA 4 transmitter enclosure (e.g., drilling) will void the manufacturer warranty.

1. Strip approximately 2-inches of the outer sheath from the sensing edge cable. Then, strip approximately 1/4-inch of the black and white interior sheaths to expose the wire.
2. Connect the sensing edge to the transmitter: **IMAGE 6**
  - a. Feed the stripped cable through the transmitter strain relief fitting.
  - b. Add a small service loop or zip tie to the sensing edge cable within the enclosure to prevent the cable from being pulled out of the terminal block when installed.
  - c. Remove the terminal block, insert each sensing edge wire into the two available positions (**not polarity sensitive**), and tighten the screws to ensure proper contact with the wire. Re-install the transmitter terminal block.
  - d. Arrange the wires inside the enclosure and tighten the strain relief fitting.
3. Test the sensing edge by squeezing to ensure proper functionality and observe the green transmitter LED turn on for about 3 seconds.
4. Mount the transmitter with the strain relief fitting pointing **down** for damp or outdoor applications.
5. Use the provided #6 x 3/4" self-drilling mounting screws in the four corner mounting holes.
6. Install the receiver and transmitter lids.

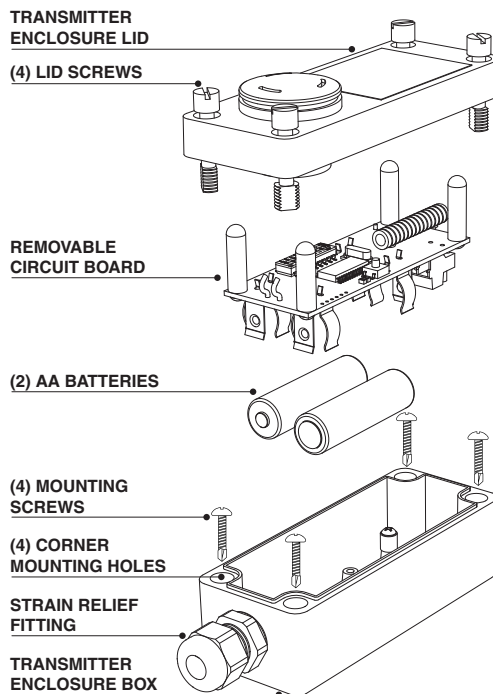

**IMAGE 4: TRANSMITTER ASSEMBLY**

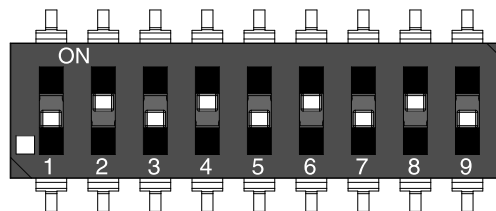

**IMAGE 5: TRANSMITTER & RECEIVER CODING SWITCHES**

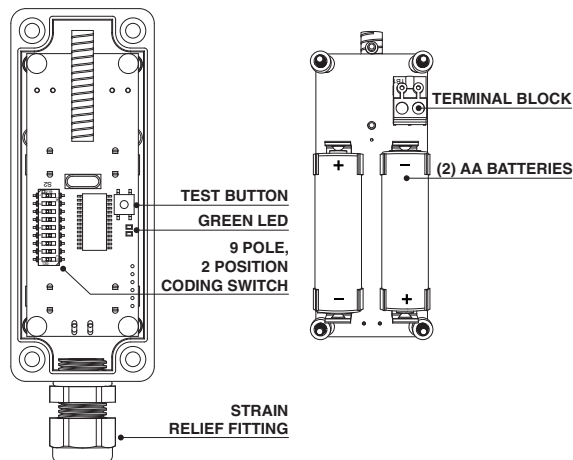

**IMAGE 6: REMOVABLE CIRCUIT BOARD DETAIL TOP (LEFT) AND BOTTOM (RIGHT)**

#### IV. FINAL TEST

While closing the door or gate, momentarily activate the sensing edge and confirm that the motor stops and/or reverses the door or gate direction.

#### V. TROUBLESHOOTING

PROBLEM	ACTION
<b><i>The sensing edge and/or transmitter aren't functioning properly.</i></b>	1. Confirm the green power receiver LED is on. <b>IMAGE 3</b>
	2. Verify the coding switches are set correctly. See <b>Section II. Transmitter Setup &amp; Pairing</b> on page 3.
	3. Press the transmitter test button and observe the green transmitter LED turns on for 3 seconds. <b>IMAGE 6</b>
	4. Check and/or replace the batteries. <b>IMAGE 4</b>
	5. Disconnect sensing edge wiring from the terminal block and press the transmitter test button. Verify the sensing edge resistance is infinite ohms when not depressed and less than 5 ohms when pressed. <b>IMAGE 6</b>
	6. If the system fails to perform after following the above steps, contact Miller Edge Tech Support at 800-220-3343.

#### VI. TECH SUPPORT

For additional assistance, contact Miller Edge Tech Support: 800-220-3343

#### VII. GENERAL SPECIFICATIONS

PERFORMANCE			
Response Time	70 milliseconds		
Operating Temperature	0°F to 130°F (-18°C to 55°C)		
Frequency	318 MHz		
Operating Range	100 ft. (optimal conditions)		
Agency Approvals	FCC		
	MWR22B RECEIVER	MWT12B TRANSMITTER	MWTA12B TRANSMITTER
ELECTRICAL			
Power Source	12-24 volts AC/DC nominal Nominal 60 mA, 140 mA activated	(2) 1.5 volts AA alkaline batteries, 2-year expectancy	(2) 1.5 volts AA lithium batteries, 2-year expectancy
Power Consumption	15 mA (avg.) with relay off; 54 mA (avg.) with relay on (1 channel)	-	-
Input/Output	Output: N.O., N.C.	Input: 2-wire N.O. edge	Input: 2-wire N.O. edge
PHYSICAL			
Dimensions	3-3/4"W x 4-13/16"H x 1-1/4"D (95 x 122 x 32 mm)	1-13/16"W x 5-3/4"H x 1-3/4"D (46 x 146 x 44 mm)	1-13/16"W x 5-3/4"H x 2-1/8"D (46 x 146 x 54 mm)
Weight	4.6 oz.	7.2 oz.	7.2 oz.
Enclosure Material	Polycarbonate	Polycarbonate	Polycarbonate
Low Battery Alert	-	-	Alarm; 80-95 dB at 2'
LED Indicators	Power, channel 1 & 2	Transmit	Transmit
Antenna	Attached wire or F connector	-	-
Wiring Connections	Integral 18" wire with #6 spade lugs	-	-
Degree of Protection	-	NEMA 4	NEMA 4

### VIII. FCC COMPLIANCE STATEMENT

#### Transmitter:

FCC ID: OYE-MWT12B0

This device complies with part 15 of the FCC Rules. Operation is subject to the following two conditions: (1) this device may not cause harmful interference, and (2) this device must accept any interference received, including interference that may cause undesired operation.

#### Receiver:

This equipment has been tested and found to comply with the limits for a Class B digital device, pursuant to part 15 of the FCC Rules. These limits are designed to provide reasonable protection against harmful interference in a residential installation. This equipment generates, uses, and can radiate radio frequency energy and, if not installed and used in accordance with the instructions, may cause harmful interference to radio communications. However, there is no guarantee that interference will not occur in a particular installation.

If this equipment does cause harmful interference to radio or television reception, which can be determined by turning the equipment off and on, the user is encouraged to try to correct the interference by one or more of the following measures:

- Reorient or relocate the receiving antenna.
- Increase the separation between the equipment and receiver.
- Connect the equipment to an outlet on a circuit different from that to which the receiver is connected.
- Consult the dealer or an experienced radio/TV technician for help.

Changes or modifications to this product could void the electromagnetic compatibility (EMC) and wireless compliance and negate your authority to operate the product.

### IX. MAINTENANCE

It is strongly recommended that users check wireless systems at least once per month for low batteries alerts, and damage to housings and mountings. Also check for signs of damage to sensing edge and cable connection points. Compress the sensing edge 2 inches from both ends and, in the center, and observe that it sends an electric signal to the controls. Refer to your operator manual for detailed instructions about motor connections.

### X. REPLACEMENT

To replace your Miller Edge wireless system, contact your sales representative. Attempting to repair your Miller Edge wireless system is not recommended and will void the manufacturer warranty.

### XI. WARRANTY

The **Two-Channel Wireless Edge Receiver (MWR22B) and Transmitter (MWT12B and/or MWTA12B) System** carry a **2-year warranty** from date of shipment from Miller Edge for credit or replacement. This warranty applies to normal use, which is found to have defective materials or workmanship, as determined solely by an authorized factory representative. This warranty is void where evidence of misuse or abuse is present. This warranty covers repair or replacement of the purchased product only; product installation/labor charges are not covered. Miller Edge manufactures its products to meet stringent specifications and cannot assume responsibility for those consequences arising from improper installation or misuse. Installation instructions and testing procedures provided by Miller Edge must be followed for proper operation and maintenance.

### XII. ACCESSORIES

Contact your Miller Edge sales representative for accessories to wireless systems:

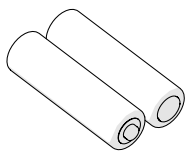

REPLACEMENT  
BATTERIES



ANTENNAS

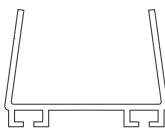

MOUNTING  
CHANNELS

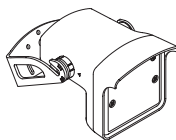

MOTION  
SENSORS

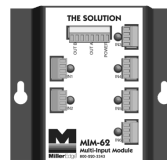

INTERFACE  
MODULES



EDGE  
TESTER

### XIII. ADDENDUM

1. MW wireless devices with a 3-position **trinary** coding switch (manufactured before 4/24) are no longer available. Discontinued models include MWR12, MWR13, MWRT12, MWRTA12, MWT12, MWTA12.
2. MW wireless devices with a 2-position **binary** coding switch (manufactured after 4/24) have replaced the previous version. Replacement models include MWR12B, MWR22B, MWRT12B, MWRTA12B, MWT12B, MWTA12B.
3. To pair a **trinary** receiver or transmitter with a **binary** receiver or transmitter, use the following guidelines:
  - a. Use **TABLE 3** and **IMAGE 7** below to assign the coding switch address between a transmitter and a receiver.
  - b. **Example 1:** If a binary transmitter switch code is set to 10010101 (SW1-8), the matching trinary receiver switch is +00-0-0-0 (SW1-9). **Note:** Binary receiver SW9 is always set to OFF (0).
  - c. **Example 2:** This also applies to the reverse: If a binary receiver switch is 100101001 (SW1-9), the matching trinary transmitter switch code is set to +00-0-00- (SW1-9).
  - d. **Invalid switch positions:** Setting trinary SW1 to -, or trinary SW2-8 to + is invalid and won't communicate with a transmitter or receiver that has a binary switch.
  - e. **SW9 Coding:**
    - The receiver SW9 should always be 0 (center position) for a trinary, and 0 (off) for a binary switch.
    - SW9 on the transmitter controls which relay on the MWR13 or MWR22B (multi-channel receiver) activates. To change relays, simply change SW9 on the transmitter.
    - If channel 1 on the MWR12 is not activating, simply move SW9 on the binary transmitter (MWT12B or MWTA12B) to another position.
  - f. Once complete, proceed to **Section II, step 3**.

**TABLE 3: CODING SWITCH MAPPING**

	TRINARY									BINARY
	SW1	SW2	SW3	SW4	SW5	SW6	SW7	SW8	SW9	SW1-9
ON	+	-	-	-	-	-	-	-	-	1
OFF	0	0	0	0	0	0	0	0	0	0
-Invalid- Do not use:	-	+	+	+	+	+	+	+	+	

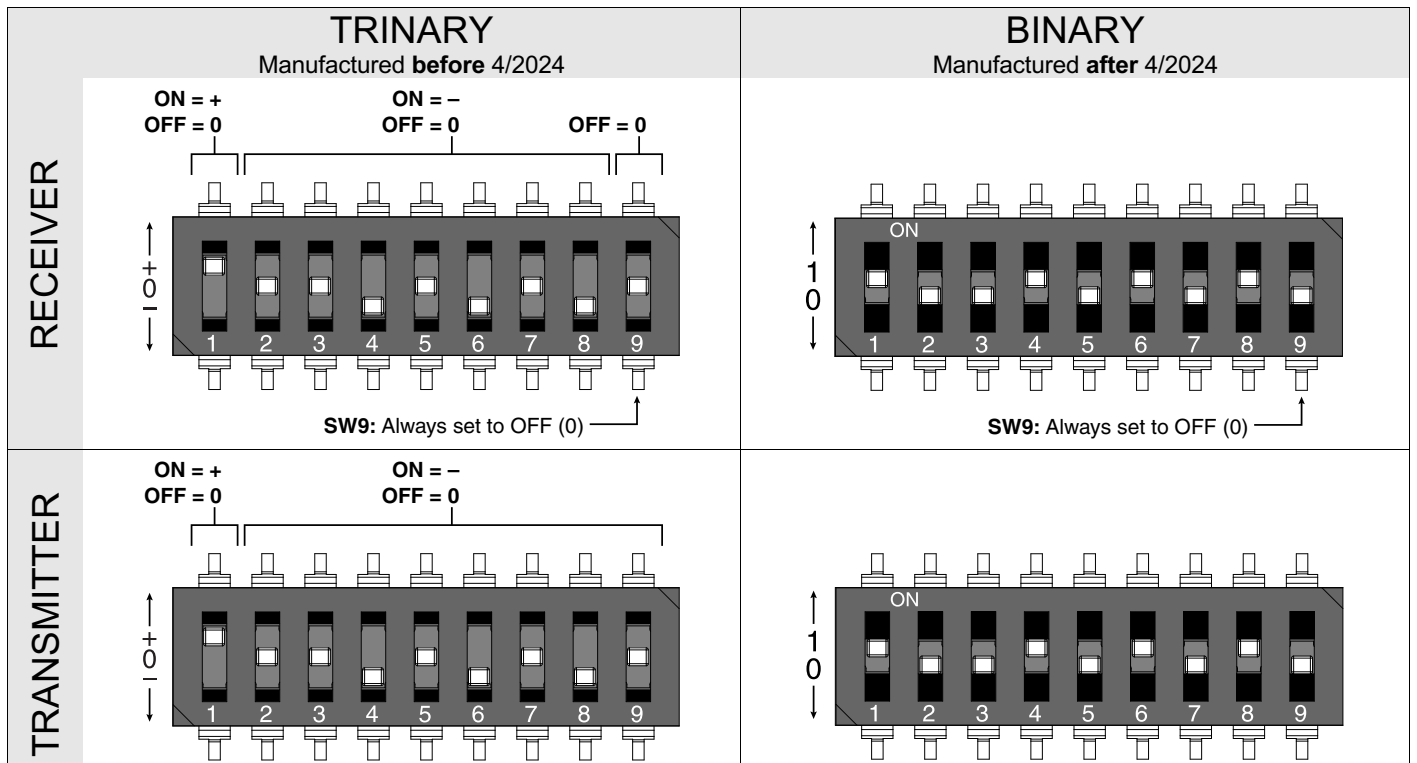

**IMAGE 7: CODING SWITCH EXAMPLE**